

**FREE
PATTERN**

Freshly Made to bring your ideas to life.



Hexi Quilt (Q-042) by Camelot Design Studio

Difficulty Level: Intermediate
Finished Size: 79" x 78"

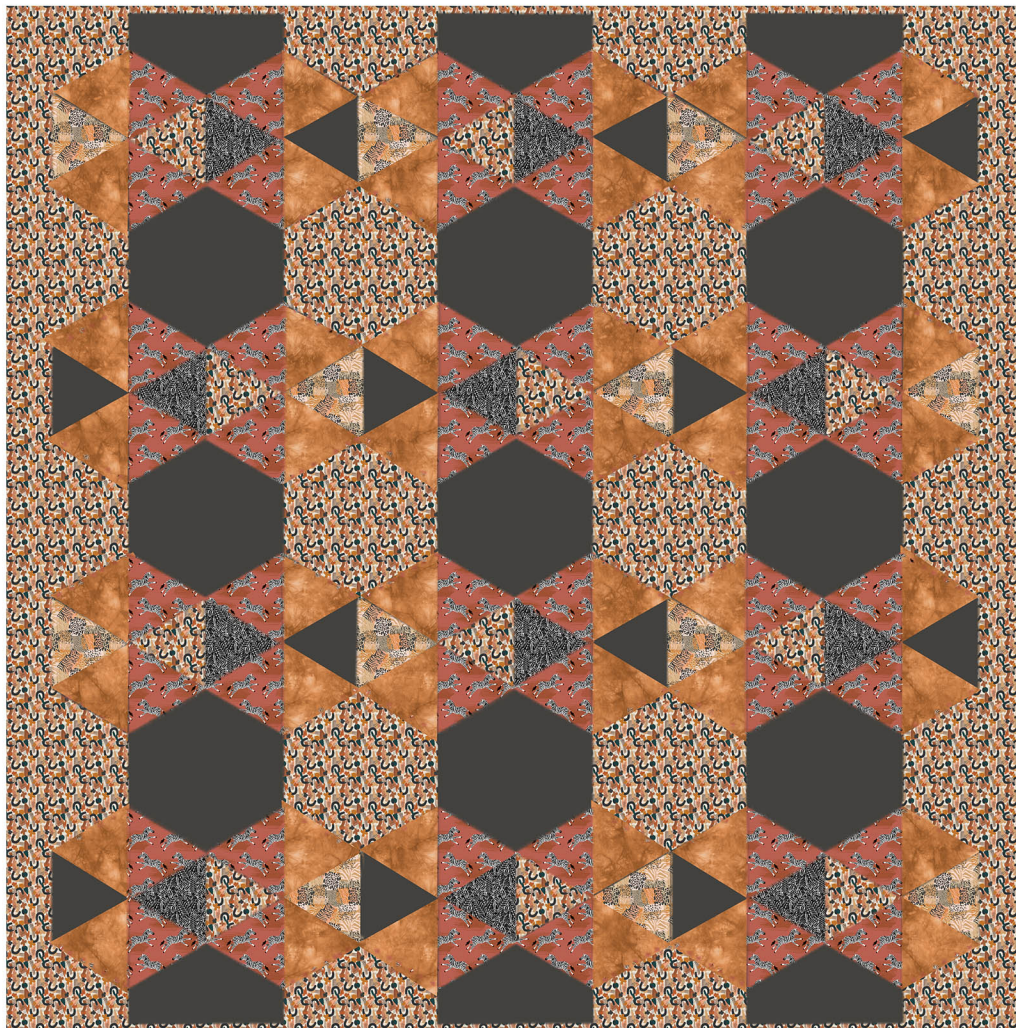

Exclusive Quilt Design by Camelot Design Studio
The direction of the fabrics in the digital imagery may not be accurate to the final product.
© Camelot Design Studio. All Rights Reserved.

Fabric requirements



Fabric A: 50220601 01
1-1/4 yards

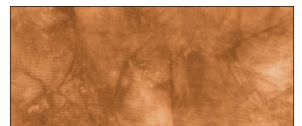

Fabric B: 21009-0044
1-1/4 yards



Fabric C: 50220608 01
1/2 yard



Fabric D: 214-0085
1/2 yard



Fabric E: 50220607 01
1/2 yard



Fabric F: 50220606 01
1/2 yard



Suggested Backing:
50220603 01
5 yards



Fabric H: 50220606 01
2-1/2 yards
(Includes binding)



Fabric G: 214-0085
1-1/2 yards



camelotfabrics.com
info@camelotfabrics.com

COLLECTION
Ubud

OTHER TOOLS & SUPPLIES

- Needle and coordinating thread
- Sewing machine
- Iron & pressing surface
- Rotary cutter and mat
- Fabric shears
- Straight pins

NOTES

- For best results, read through all instructions before starting.
- Please wash, dry & iron your fabrics before beginning, and trim selvages.
- Unless otherwise indicated, sew all seams with a 1/4" seam allowance.
- Press your seams open as you go.
- WOF = width of fabric

CUTTING

Fabric A & B

Cut (6) 7" x WOF Strips from each Fabric. Sub-cut each strip into (8) triangles (NOTE: Follow the instructions on How To Cut Equilateral Triangles found on p.6)

Fabric C-D-E & F

Cut (2) 7" x WOF strips from each fabric. Sub-cut to make (12) triangles from each fabric (NOTE: Follow the instructions on How To Cut Equilateral Triangles found on p. 6)

Fabric G

Cut (8) 7" x WOF strips. From (6) of the strips, sub-cut 18 trapezoids (NOTE: Follow the instructions on How To Cut Trapezoids found on p.8)

Sub-cut the (2) remaining strips into (12) "half trapezoids" (NOTE: Follow the instructions on How to Cut Half Trapezoids found on p.9)

Fabric H

Cut (8) 7" x WOF strips. From (6) of the strips, Sub-cut (18) Trapezoids.

Sub-cut the (2) remaining strips into (12) "half trapezoids".

Cut (4) 4" x WOF strips. Sew (2) of these strips together, end to end, and trim to 78-1/2" long. Repeat with the (2) remaining strips. These will be referred to as the side borders.

CUT (9) 2-1/2" x WOF strips. Set aside for binding.



PIECING

The following steps describe how to piece triangles and trapezoids side by side. Once you learn the technique, you can follow the assembly layout on p.5 and on the cover page to piece the columns for the quilt top.

Piecing triangles

1. Place (2) triangles one over the other, Right Sides Facing, making sure to line up all edges. Sew a seam along one edge. Press seams open.

NOTE: if you are working with a DIRECTIONAL print, be sure to orient your fabrics correctly.

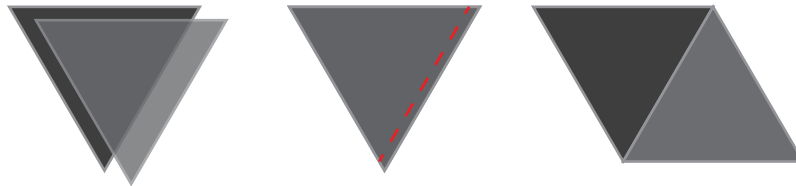

Piecing triangles and Trapezoids

2. Place (1) trapezoid over (1) triangle, right sides facing, making sure to line up the edges that will be sewn.

NOTE: Line up the trapezoid along the triangle's edge so that it extends 1/4" off the top. Consequently, the triangle's corner will protrude off the bottom of the trapezoid by 1/4".

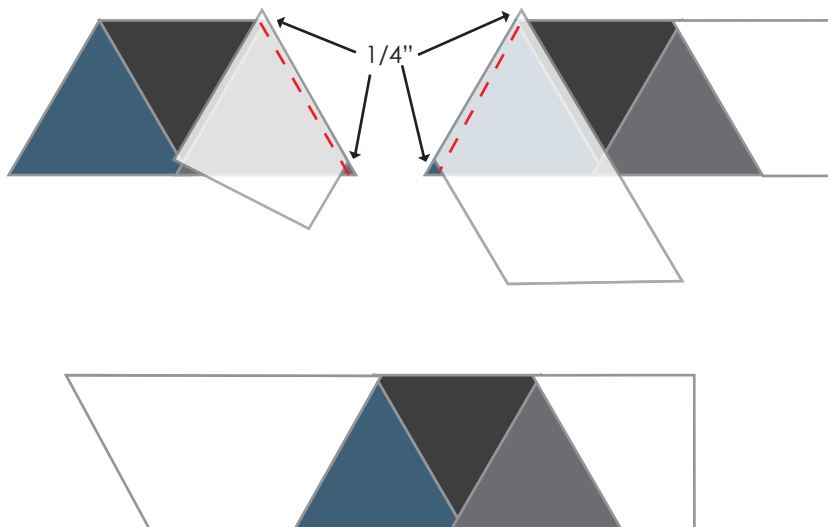

Piecing the columns

3. Follow the assembly layout on p.5, as well as the cover page, when piecing the columns.
Note that columns 1, 5 and 9 are the same, as are: 2, 6 and 10; 3, 7 and 11; 4, 8 and 12.

Columns 1, 5 and 9

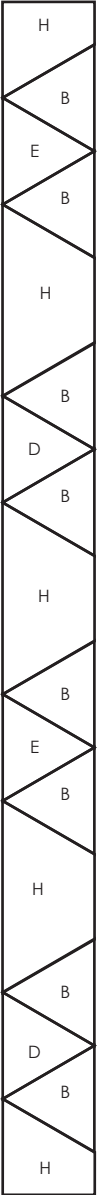

Columns 2, 6 and 10

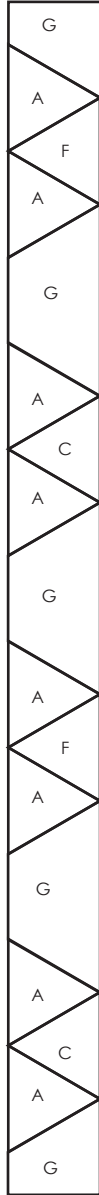

Column 3, 7 and 11



Column 4, 8 and 12

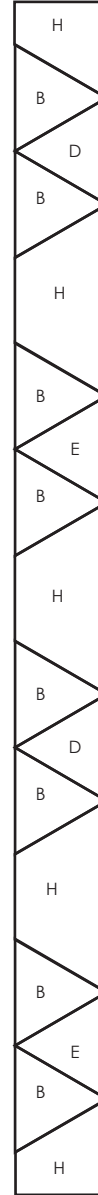

ASSEMBLY

4. Sew all columns together from left to right. Pin the columns before sewing, making sure to match your seams.

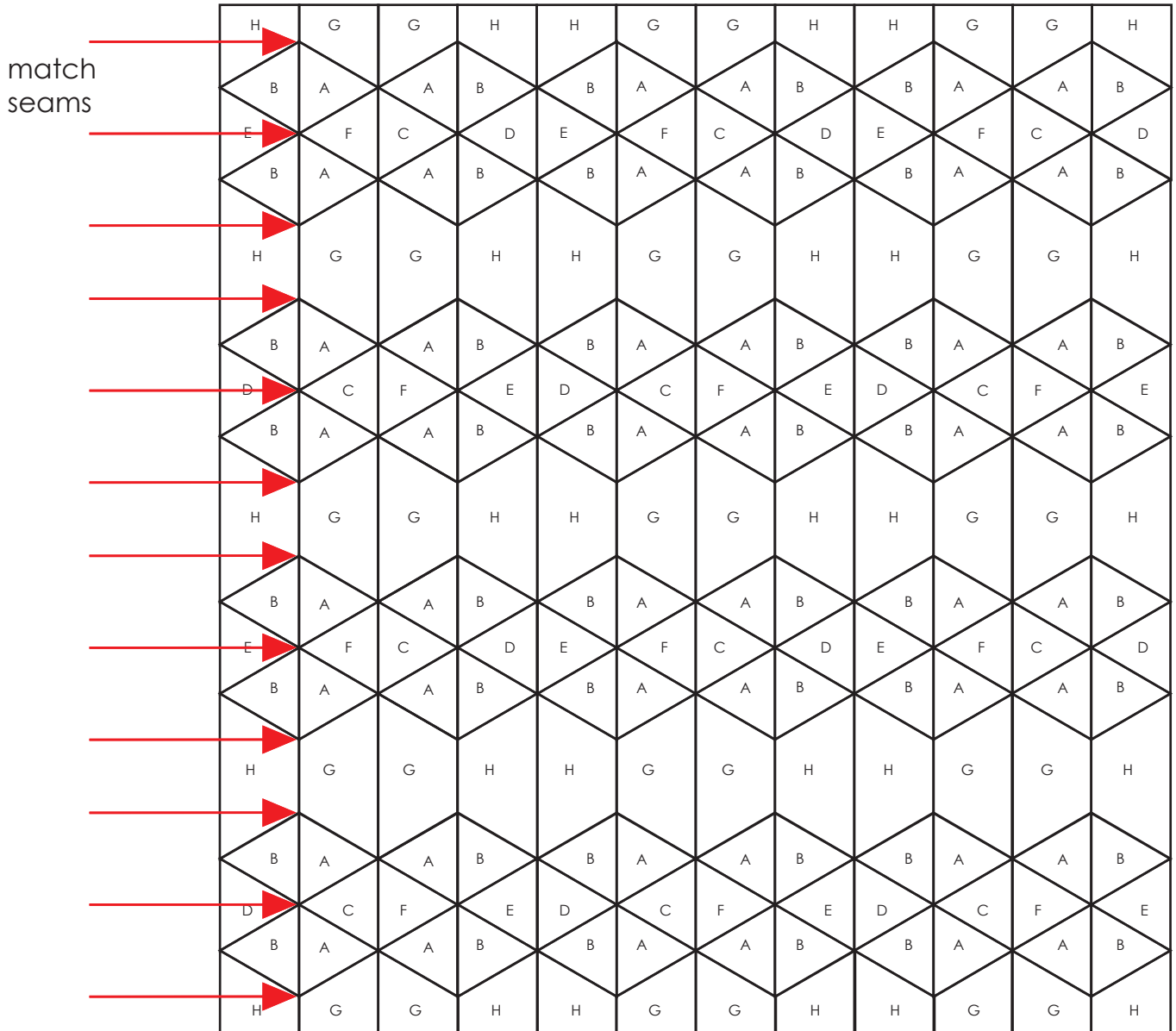

5. Sew (1) side border to either side of the unit created in Step 4. This completes the quilt top.

FINISHING

6. Layer the quilt top with batting and backing. Baste and quilt as desired.
7. Sew the Fabric H binding strips together end-to-end and press seams open. Bind the quilt using your favorite method.

ASSEMBLY LAYOUT

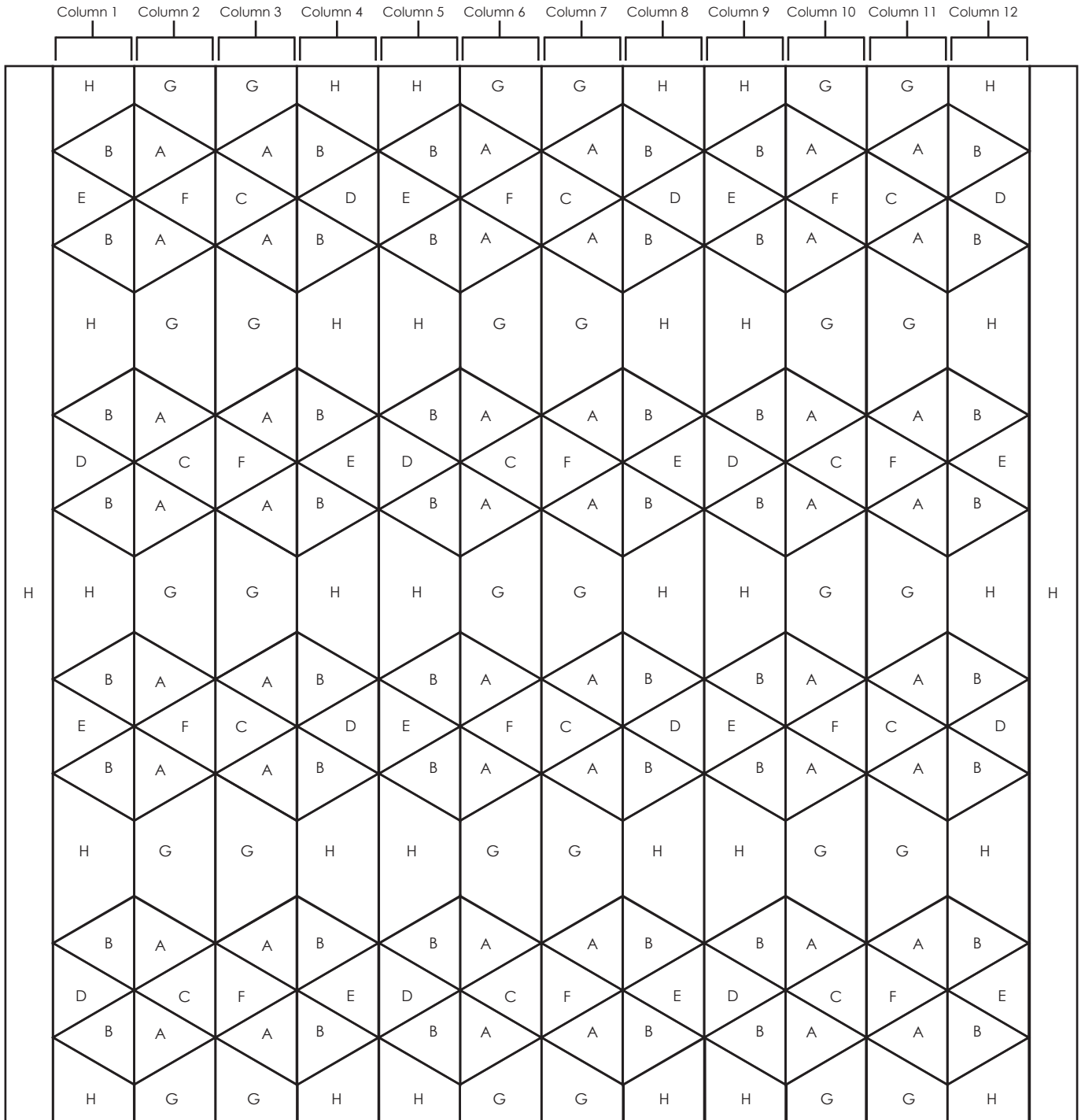

WORKING WITH THE 60° LINES ON YOUR QUILTING RULER

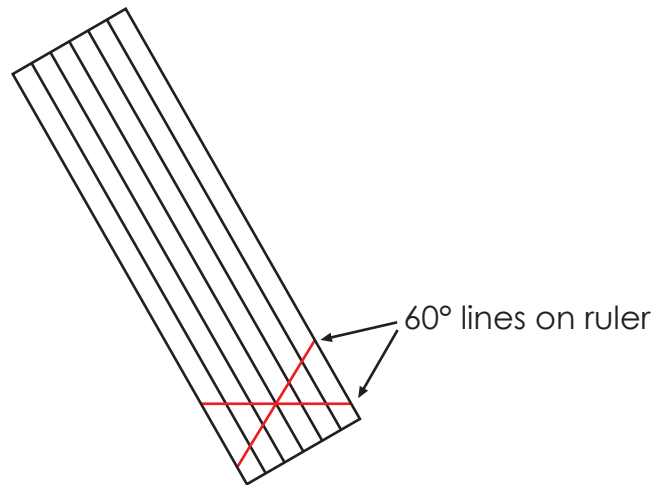

HOW TO CUT EQUILATERAL TRIANGLES USING THE 60 ° LINES ON YOUR RULER :

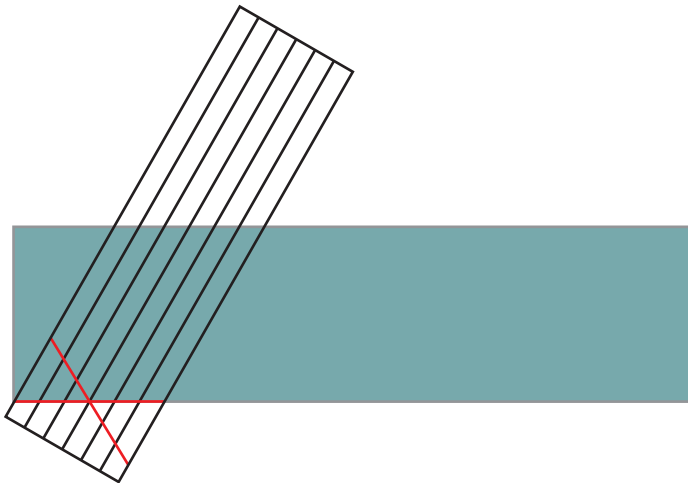
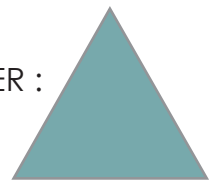

1. Lay your ruler on the fabric strip, making sure to align the 60° line with the bottom edge of your strip. The ruler should be tilted towards the right and the left side of your ruler should line up with the lower left corner of the fabric strip, as shown.

2. Cut along the left side of your ruler. Note: for this step it helps to have a table that you can walk around so that you are not cutting towards yourself.

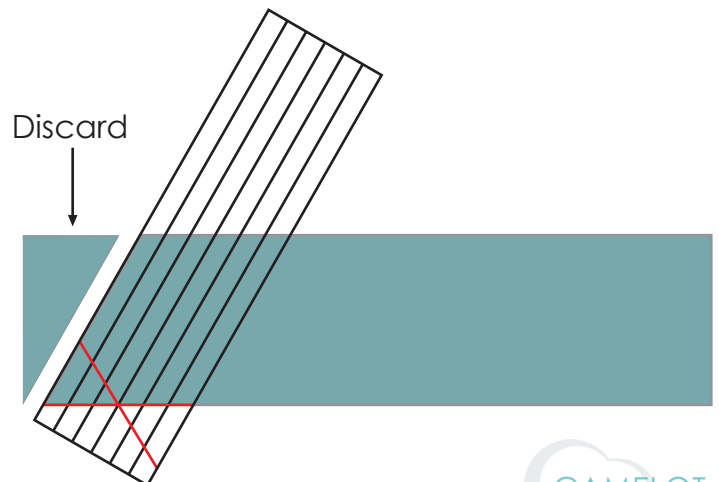

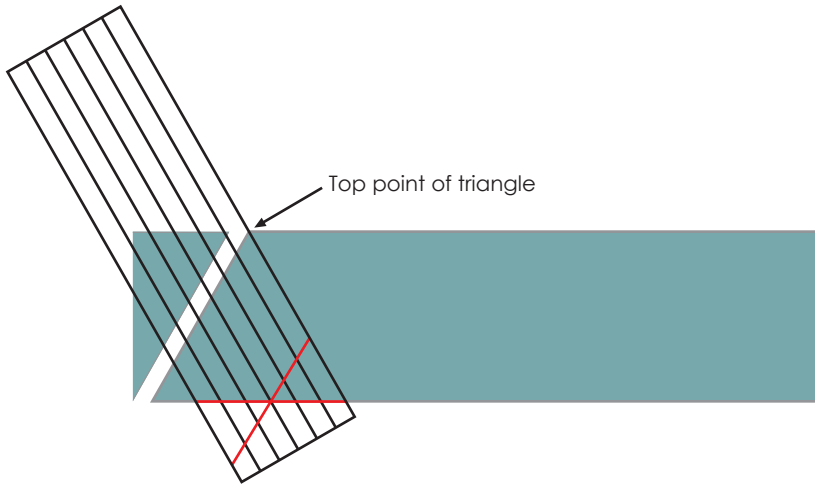

3. Tilt your ruler towards the left and line up the other 60° line with the bottom edge of the strip. The right side of the ruler should be lined up with the top point of the triangle.

4. Cut along the right side of your ruler.

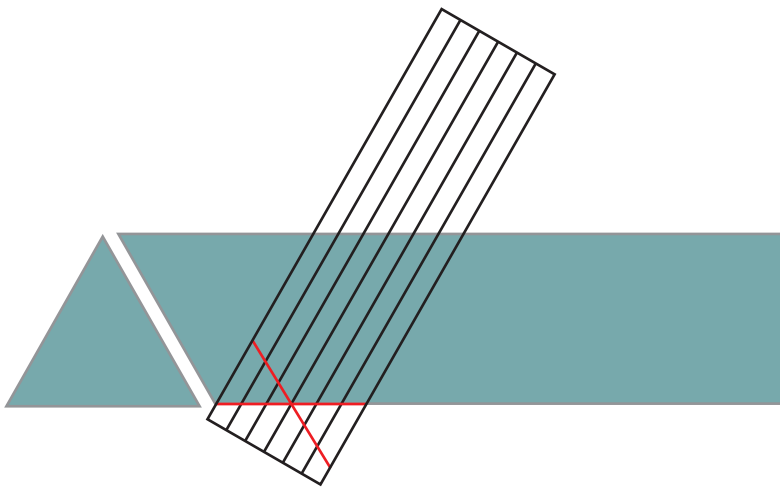
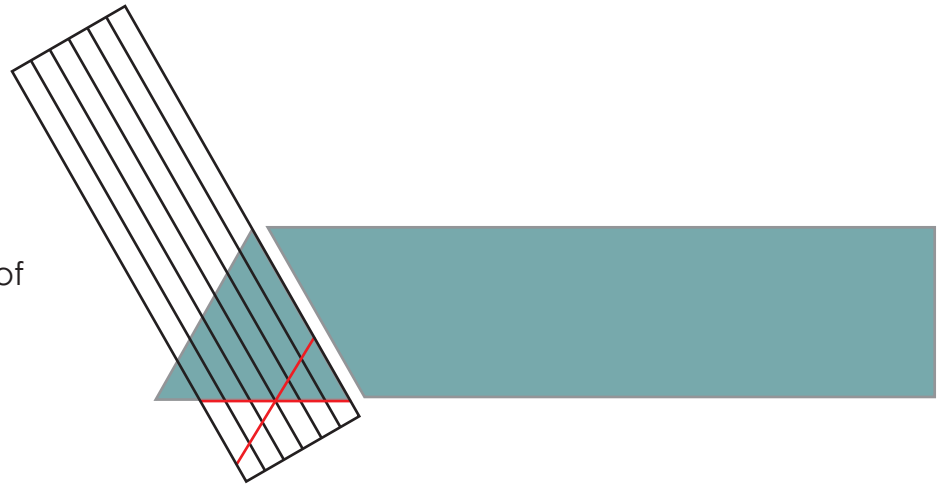

5. Continue to cut triangles along the fabric strip by tilting your ruler towards the right & left as needed and lining up the 60° lines of your ruler as you did in previous steps.

HOW TO CUT TRAPEZOIDS USING THE 60° LINE ON YOUR RULER



6. Begin by following Steps 1 & 2 from the instructions for cutting triangles.

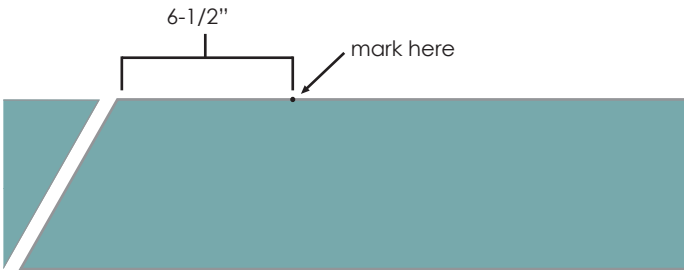

7. Measure 6-1/2" away from the top corner of the first cut and mark it with a fabric marker.

8. Tilt your ruler towards the left and line up the 60° line with the bottom edge of the strip. The right hand side of your ruler should be lined up with the top edge of the fabric strip at the 6-1/2" mark that you made in Step 7. Cut along the right side of the ruler.

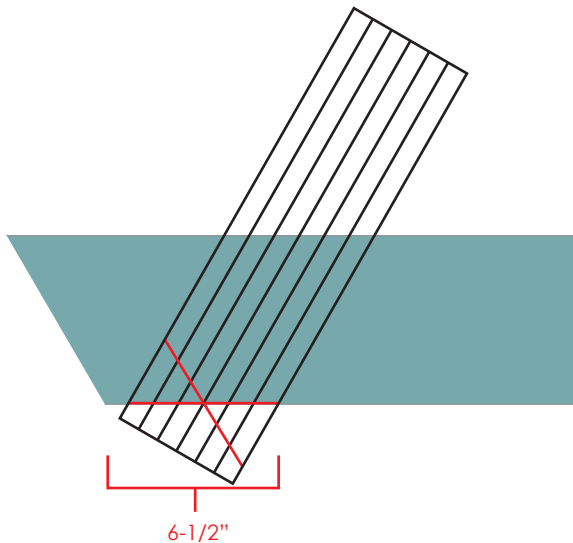
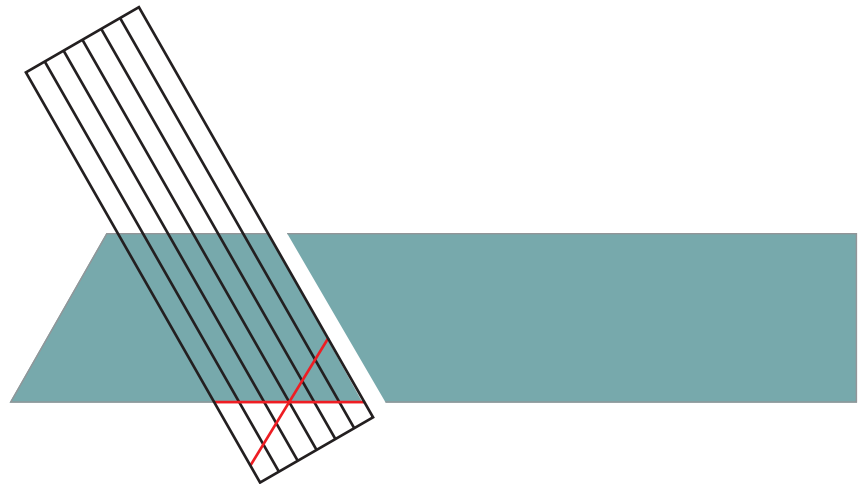

9. Tilt and slide your ruler towards the right. Line up the 60° line with the bottom edge of the fabric. The right side of the ruler should be 6-1/2" away from the bottom left corner of the fabric strip. Cut along the right side of the ruler. Continue to cut trapezoids in this manner along the rest of the fabric strip.

HOW TO CUT "HALF TRAPEZOIDS" USING THE 60° LINES ON YOUR RULER



10. Trim the short edge on the left side of the fabric strip so that you have a neat 90° cut.

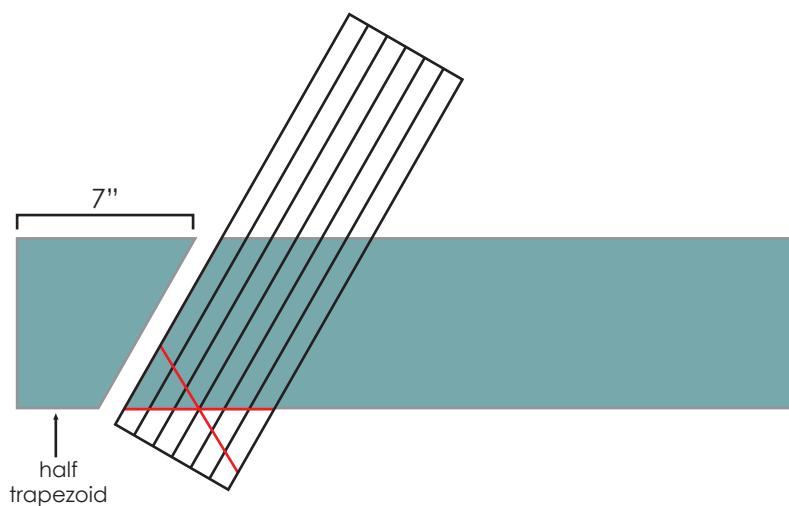

11. Tilt your ruler towards the right and line up the 60° line with the bottom edge of the strip. The left side of your ruler should be 7" away from the top left corner of the fabric strip. Make a cut on the left side of your ruler.

12. Tilt your ruler so that it is perpendicular to the fabric strip and slide it towards the right. Make a cut 7" away from the bottom left corner, as shown.

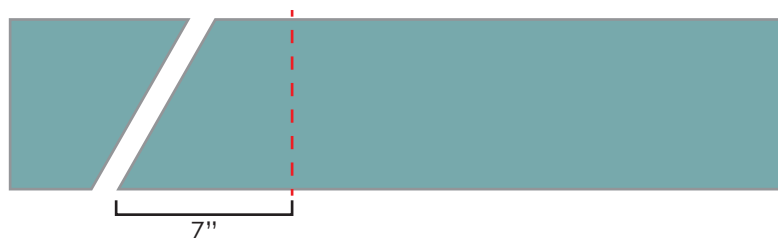

13. Repeat Steps 11 & 12 to cut all of your half trapezoids.

